

# E-Tech P

57 - 115 - 144 - 201 - 259

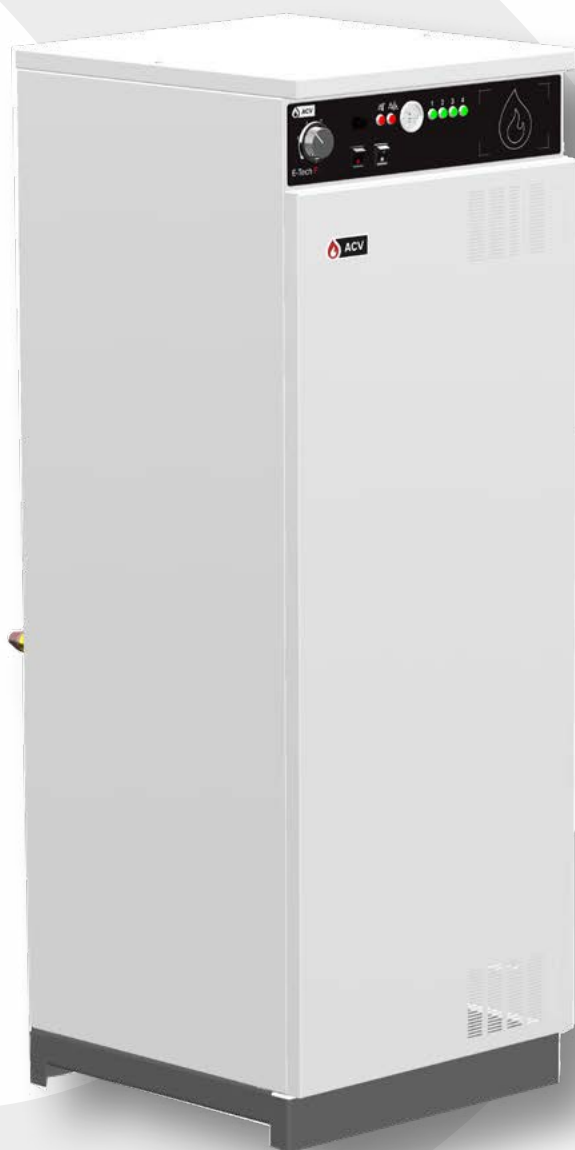

## INSTALLATION, OPERATION & MAINTENANCE

Instructions for the User and the Installer

<b>GENERAL INFORMATION .....</b>	<b>3</b>	Sizing of supply wires .....	14
Meaning of Symbols.....	4	Control Circuit Terminal.....	14
What to Check on a Regular Basis.....	4	<b>COMMISSIONING .....</b>	<b>15</b>
Boiler Marking.....	4	Safety Instructions for starting up.....	15
<b>USER'S GUIDE.....</b>	<b>5</b>	Checks and setup before start up.....	15
Using the Control Panel .....	5	Filling the system .....	15
Product Description.....	6	Starting the boiler .....	16
Power variation (kW) relative to voltage.....	6	<b>MAINTENANCE.....</b>	<b>17</b>
<b>TECHNICAL SPECIFICATIONS.....</b>	<b>7</b>	Recommendations for the boiler maintenance .....	17
Hydraulic Characteristics.....	7	Boiler Shut-down for Maintenance .....	17
Electrical Characteristics .....	7	Draining the Boiler.....	17
Recommendations for the prevention of corrosion and scaling in Heating Systems.....	8	Boiler maintenance.....	18
Checking the Safety Devices .....	8	Resetting the High Limit Safety Thermostat .....	18
<b>INSTALLATION .....</b>	<b>9</b>	Replacing the Heating Elements .....	19
Tools required for the installation.....	9		
Package Contents.....	10		
Handling instructions.....	10		
Removing the boiler from the packaging.....	10		
Removal and Installation of the Access Panels.....	10		
Recommendations for the hydraulic installation.....	11		
Heating Connection .....	11		
Heating Circuit + DHW (2 Circulating pumps).....	12		
Safety instructions for the electrical installation.....	13		
Electrical Connections.....	13		
Power Limitation .....	14		

We accept no liability should any damage result from the failure to comply with the instructions contained in this technical manual.

This manual contains important information with respect to the installation, the starting up and the maintenance of the appliance.

This manual must be provided to the user, who will read it carefully and keep it in a safe place.

## Essential instructions for safety

- It is prohibited to carry out any modifications to the appliance without the manufacturer's prior and written agreement.
- The product must be installed by a qualified engineer, in accordance with applicable local standards and regulations.
- The installation must comply with the instructions contained in this manual and with the standards and regulations applicable to heating systems.
- Failure to comply with the instructions in this manual could result in personal injury or a risk of environmental pollution.
- The manufacturer declines all liability for any damage caused as a result of incorrect installation or in the event of the use of appliances or accessories that are not specified by the manufacturer.

## Essential instructions for the correct operation of the appliance

- In order to ensure that the appliance operates correctly, it is essential to have it serviced by a certified installer or maintenance contractor every year.
- In case of anomaly, please call your service engineer.
- Faulty parts may only be replaced by genuine factory parts.

## General remarks

- The availability of certain models as well as their accessories may vary according to markets.
- The manufacturer reserves the right to change the technical characteristics and features of its products without prior notice. Please check for an updated version of this manual in the documentation page on the website [www.acv.com](http://www.acv.com).
- In spite of the strict quality standards that ACV applies to its appliances during production, inspection and transport, faults may occur. Please immediately notify your approved installer of any faults.

## GENERAL SAFETY INSTRUCTIONS FOR ELECTRIC APPLIANCES

**BEFORE CARRYING OUT ANY WORK ON THE BOILER, MAKE SURE THAT ALL ELECTRICAL SUPPLIES ARE ISOLATED.**

**MAKE SURE THAT THE WIRING SYSTEM AND THE POWER INPUT LINES ARE DESIGNED AND INSTALLED BY A REGISTERED COMPANY, IN COMPLIANCE WITH THE APPLICABLE REGULATIONS.**

**DO NOT STORE ANY FLAMMABLE OR CORROSIVE PRODUCTS, PAINT, SOLVENTS, SALTS, CHLORIDE PRODUCTS AND OTHER DETERGENT PRODUCTS NEAR THE APPLIANCE.**

**THIS APPLIANCE IS NOT INTENDED FOR USE BY PERSONS (INCLUDING CHILDREN) WITH REDUCED PHYSICAL, SENSORY OR MENTAL CAPABILITIES, OR LACK OF EXPERIENCE AND KNOWLEDGE, UNLESS SUPERVISED OR UNLESS THEY HAVE BEEN GIVEN INSTRUCTIONS CONCERNING THE USE OF THE APPLIANCE BY A PERSON RESPONSIBLE FOR THEIR SAFETY.**

**CHILDREN SHALL NOT PLAY WITH THE APPLIANCE.**

### MEANING OF SYMBOLS

#### Symbols on the packaging



Fragile



Keep dry



Keep standing, up



Danger of tipping over



Hand truck or pallet truck required for transport

#### Symbols on the appliance



Domestic Hot Water circuit



Primary circuit



Electricity

#### Symbols in the manual



Essential recommendation for safety (of persons and equipment)



Essential recommendation for electrical safety (electrical hazard)



Essential recommendation for the correct operation of the appliance or the system



General remark



Safety valve connected to the sewage system



Connection to the sewage system

### WHAT TO CHECK ON A REGULAR BASIS



Essential recommendations for the correct operation of the appliance

- Check regularly that the system water pressure is at least 1 bar when cold. If the pressure drops below 0.5 bar, the built-in pressure sensor blocks the appliance until the pressure exceeds 0.8 bar.
- If it is required to top up the system to maintain the minimum recommended water pressure, always turn the appliance off and only add small amounts of water at a time. If a large amount of cold water is added in a hot boiler, the appliance can be damaged definitively.
- If the system needs to be refilled repeatedly with water, or if there is water on the floor under the boiler, contact your service engineer.

### BOILER MARKING

Location: Back panel



The part number (Code) and serial number (S/N) of the appliance are indicated on its rating plate and must be provided to ACV in case of warranty claim. Failure to do so will make the claim void.

## USING THE CONTROL PANEL

1. **Control thermostat** - Allows to define the temperature setpoint for the primary circuit. Each number around the dial corresponds to a specific temperature:
  - 1 = 25°C
  - 2 = 40°C
  - 3 = 55°C
  - 4 = 70°C
  - 5 = 85°C
2. **ON/OFF switch** - to start and stop the appliance.
3. **Summer/Winter switch** - Allows the operation of the boiler for the exclusive production of Domestic Hot Water, if an external tank is installed.
4. **Manual reset high limit thermostat** - If the boiler temperature exceeds 103°C, the safety device is activated and the indicator light is turned on. Refer to *"Resetting the High Limit Safety Thermostat"* on page 18 for the reset procedure.
5. **Overheating Indicator light** - The lamp turns on when the safety thermostat is activated because the primary circuit temperature is too high (103°C).
6. **Low pressure indicator light** - The lamp turns on when the water pressure is too low in the primary circuit.
7. **Combined temperature and pressure gauge** - Allows the direct reading of both temperature and pressure of the boiler primary circuit.
8. **Power Indicators** - These lamps indicate the level of power that is produced by the boiler, according to the stages that are activated.
9. **Location for optional internal controller** - Refer to the manual provided with the accessory.

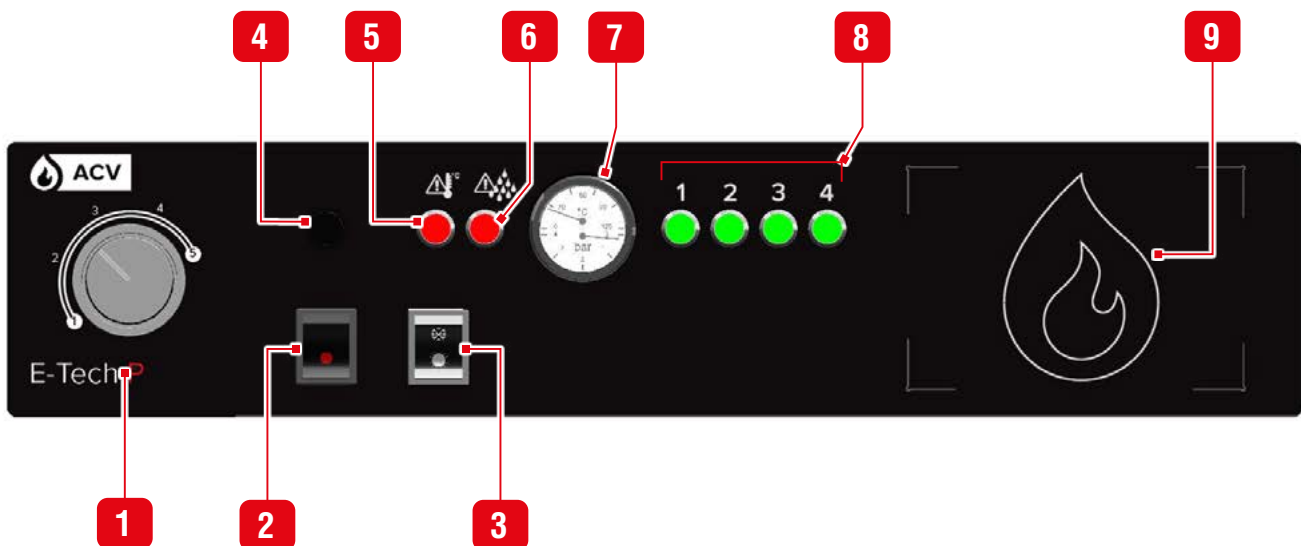

## PRODUCT DESCRIPTION

This floor-standing electric boiler is available in 5 models:

E-Tech P 57	57.6 kW
E-Tech P 115	115.2 kW
E-Tech P 144	144.0 kW
E-Tech P 201	201.6 kW
E-Tech P 259	259.2 kW



- The power circuit is supplied with three-phase 400 Volt, without neutral.
- The control circuit is supplied with single-phase 230 Volt.

### Casing

The boiler is protected by a steel casing that first undergoes a degreasing and phosphation process before being lacquered and burnt at 220°C.

### Heating body

The heating body is constructed from mild steel with welded joints. It is hydraulically tested at 5.2 bar (maximum operating pressure = 4 bar).

### Heating elements

Removable heating elements, constructed from stainless steel Incoloy 800 and mounted from the front of the heating body.

### Connection

The boiler is suitable for connection to most sealed heating and hot water systems, with a maximum working pressure of 4 bar and a maximum temperature of 90°C.

### Control

The boiler is equipped with an electronic sequencing controller that constantly adapts the required power required through a four-stage modulation. The boiler can also be controlled by an external contact (i.e. room thermostat). The maximum power can be limited to 25%, 50% or 75% of the nominal power by adding/removing electrical bridges.

### Electric Protection

The control circuit is protected by an internal 3 Amp MCB. The power circuit is protected at its input by 3 power fuses.

In addition, each contactor - supplying a pair of electric stars (28,8kW) - is protected by an automatic thermal and magnetic safety relay.

### Frost protection

The boiler is NOT fitted with frost protection. If the boiler is being installed in a position where freezing could take place, then a suitable external frost thermostat should be fitted.

## POWER VARIATION (KW) RELATIVE TO VOLTAGE

Models	3 x 380 V	3 x 400 V	3 x 415 V	3 x 440 V
E-Tech P / 57	51.4	57.6	62.0	70
E-Tech P / 115	103.8	115.2	124.0	139
E-Tech P / 144	130.0	144.0	155.0	174
E-Tech P / 201	181.4	201.6	217.0	244
E-Tech P / 259	233.7	259.2	279.0	314

## HYDRAULIC CHARACTERISTICS

		E-TECH P				
		57	115	144	201	259
Capacity (primary)	L	60	60	60	102	102
Min. operating pressure	bar	0.8				
Max operating pressure	bar	4				
Hydraulic pressure drop ( $\Delta T = 10^{\circ}\text{C}$ )	mbar	20	79	123	20	33
Max temperature	$^{\circ}\text{C}$	90 $^{\circ}\text{C}$				

Also refer to "*Recommendations for the prevention of corrosion and scaling in Heating Systems*" on page 8

## ELECTRICAL CHARACTERISTICS

			E-TECH P				
			57	115	144	201	259
Power		kW	57.6	115.2	144	201.6	259.2
Nominal supply voltage	Power circuit	V	3 x 400	3 x 400	3 x 400	3 x 400	3 x 400
	Control circuit	V	1 x 230 V 50/60 Hz	1 x 230 V 50/60 Hz	1 x 230 V 50/60 Hz	1 x 230 V 50/60 Hz	1 x 230 V 50/60 Hz
Number of heating elements			2	4	5	7	9
Ohmic value of single resistance (2.4 kW)		Ohm	22	22	22	22	22

### NOMINAL CURRENT PER PHASE

Models	Stage 1 (A)	Stage 2 (A)	Stage 3 (A)	Stage 4 (A)	Total current per phase (A)
E-Tech P 57	20.9	20.9	20.9	20.9	83.6
E-Tech P 115	41.7	41.7	41.7	41.7	166.8
E-Tech P 144	62.6	62.6	41.7	41.7	208.7
E-Tech P 201	83.5	83.5	62.6	62.6	292.2
E-Tech P 259	83.5	104.4	83.5	104.4	375.8

### POWER

Models	Power (kW) Stage 1	Power (kW) Stage 2	Power (kW) Stage 3	Power (kW) Stage 4	Total power (kW)
E-Tech P 57	14.4	14.4	14.4	14.4	57.6
E-Tech P115	28.8	28.8	28.8	28.8	115.2
E-Tech P 144	43.2	43.2	28.8	28.8	144.0
E-Tech P 201	57.6	57.6	43.2	43.2	201.6
E-Tech P 259	57.6	72.0	57.6	72.0	259.2



Also refer to "*Wiring Diagrams*" on page 4 of ML manual for the complete wiring diagrams.

## RECOMMENDATIONS FOR THE PREVENTION OF CORROSION AND SCALING IN HEATING SYSTEMS

### How oxygen and carbonates can affect the heating system

Oxygen and dissolved gasses in the water of the primary circuit contribute to the oxidation and the corrosion of the system components that are made of ordinary steel (radiators, ...). The resulting sludge is then deposited in the appliance exchanger.

The combination of carbonates and carbon dioxide in the water results in the formation of scale on the hot surfaces of the installation, including those of the appliance exchanger.

These deposits in the heat exchanger reduce the water flow rate and thermally insulate the exchange surfaces, which is likely to damage them.

### Sources of oxygen and carbonates in the heating circuit

The primary circuit is a closed circuit; the water it contains is therefore isolated from the mains water. When maintaining the system or filling up the circuit, water renewal results in the addition of oxygen and carbonates in the primary circuit. The larger the water volume in the system, the larger the addition.

Hydraulic components without an oxygen barrier (PE pipes and connections) admit oxygen into the system.

### Prevention Principles

#### 1. Clean the existing system before installing a new appliance

Before the system is filled, it must be cleaned in accordance with standard EN14336. Chemical cleaning agents can be used.

If the circuit is in bad condition, or the cleaning operation was not efficient, or the volume of water in the installation is substantial (e.g. cascade system), it is recommended to separate the appliance from the heating circuit using a plate-to-plate exchanger or equivalent. In that case, it is recommended to install a hydrocyclone or magnetic filter on the installation side.

#### 2. Limit the fill frequency

Limit fill operations. In order to check the quantity of water that has been added into the system, a water meter can be installed on the filling line of the primary circuit.

Automatic filling systems are not recommended unless the fill frequency is monitored and the scale and corrosion inhibitor remain at the correct levels.

If your installation requires frequent water refilling, make sure your system is free of water leaks.

Inhibitors may be used in accordance with standard EN 14868.

#### 3. Limit the presence of oxygen and sludge in the water

A deaerator (on the appliance flow line) combined with a dirt separator (upstream of the appliance) must be installed according to the manufacturer's instructions.

ACV recommends using additives that keep the oxygen in solution in the water, such as Fernox ([www.fernox.com](http://www.fernox.com)) and Sentinel ([www.sentinel-solutions.net](http://www.sentinel-solutions.net)) products.

The additives must be used in accordance with the instructions issued by the manufacturer of the water treatment product.

#### 4. Limit the carbonate concentration in the water

The fill water must be softened if its hardness is higher than 20° fH (11,2° dH).

Check regularly the water hardness and enter the values in the service log.

#### Water hardness table :

Water hardness	°fH	°dH	mmolCa(HCO <sub>3</sub> ) <sub>2</sub> / l
Very soft	0 - 7	0 - 3.9	0 - 0.7
Soft	7 - 15	3.9 - 8.4	0.7 - 1.5
Fairly hard	15 - 25	8.4 - 14	1.5 - 2.5
Hard	25 - 42	14 - 23.5	2.5 - 4.2
Very hard	> 42	> 23.5	> 4.2

#### 5. Control the water parameters

In addition to the oxygen and the water hardness, other parameters of the water must be checked.

Treat the water if the measured values are outside the range.

Acidity	6,6 < pH < 8,5
Conductivity	< 400 µS/cm (at 25°C)
Chlorides	< 125 mg/l
Iron	< 0,5 mg/l
Copper	< 0,1 mg/l



## SAFETY INSTRUCTIONS FOR THE INSTALLATION



### General remarks

- The connections (electrical, hydraulic) must be carried out in accordance with current applicable standards and regulations.



### Essential recommendations for the correct operation of the appliance

- The boiler must be installed in a dry and protected area, with an ambient temperature comprised between 0°C and 45°C.
- Install the appliance to ensure easy access at all times.
- Make sure to install a pressure reducing valve set at 4.5 bar if the mains supply pressure is in excess of 6 bar.



### Essential recommendations for safety

- Install the boiler on a base made of non-combustible materials.
- Do not use or store any flammable, explosive or corrosive products, such as paint, solvents, salts, chloride products and other detergent products near the appliance
- This appliance is not constructed for installation in zone 3.



### Essential recommendations for the electrical safety

- Only an approved installer is authorized to carry out the electrical connections.
- The appliance must be connected to the earth.
- Install a 2-way switch and a fuse or circuit breaker of the recommended rating outside the appliance, so as to be able to shut power down when servicing the appliance or before performing any operation on it.
- Isolate the external electrical supply of the appliance before performing any operation on the electrical circuit.
- This appliance is not intended for use by persons (including children) with reduced physical, sensory or mental capabilities, or lack of experience and knowledge, unless supervised or unless they have been given instruction concerning the use of the appliance by a person responsible for their safety.

## TOOLS REQUIRED FOR THE INSTALLATION

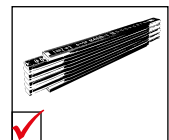
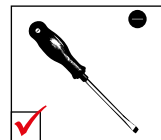
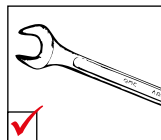
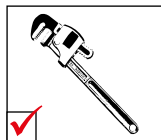
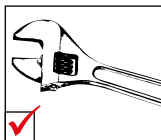
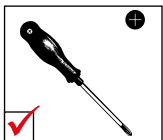

## PACKAGE CONTENTS

The E-Tech P boilers are delivered assembled and packaged.



**At product reception and after removal of packaging, check the package contents and that the appliance is free of damages.**

- One E-Tech P boiler
- Installation, Operation and Maintenance Instructions

## HANDLING INSTRUCTIONS



- The weight of this boiler is more than 100Kg, which could present a risk of injury. Ask for help to lift it or handle it, and use an appropriate transport/lifting means.
- Bring the appliance as close as possible to the installation location before removing the packaging.

## REMOVING THE BOILER FROM THE PACKAGING



**Before removing the packaging, ensure that the installation area is clear and that there are no obstacles, that would make the installation difficult or unsafe.**

1. Remove the packaging as well as the protection pieces and discard in accordance with applicable local regulations.
2. With help from another person and an appropriate means of transport, bring the boiler to its location of installation.

## REMOVAL AND INSTALLATION OF THE ACCESS PANELS

### Set-up conditions

- Boiler shut down using the ON/OFF switch
- External power supply isolated (through the external electrical box)
- Boiler cooled down (if it was in operation)



**Before any operation on the system, make sure that the boiler has cooled down and that the electrical supply is isolated.**

### Procedure

#### Right panel:

1. Release eight screws. Retain for reinstallation.
2. Remove the panel

#### Top panel:

1. Release two screws. Retain for reinstallation
2. Remove the panel.

#### Front panel:

1. Release two screws located under the control panel. Retain for reinstallation.
2. Remove the panel.

### Follow-on tasks

Perform the operation in the reverse sequence to reinstall the panels.

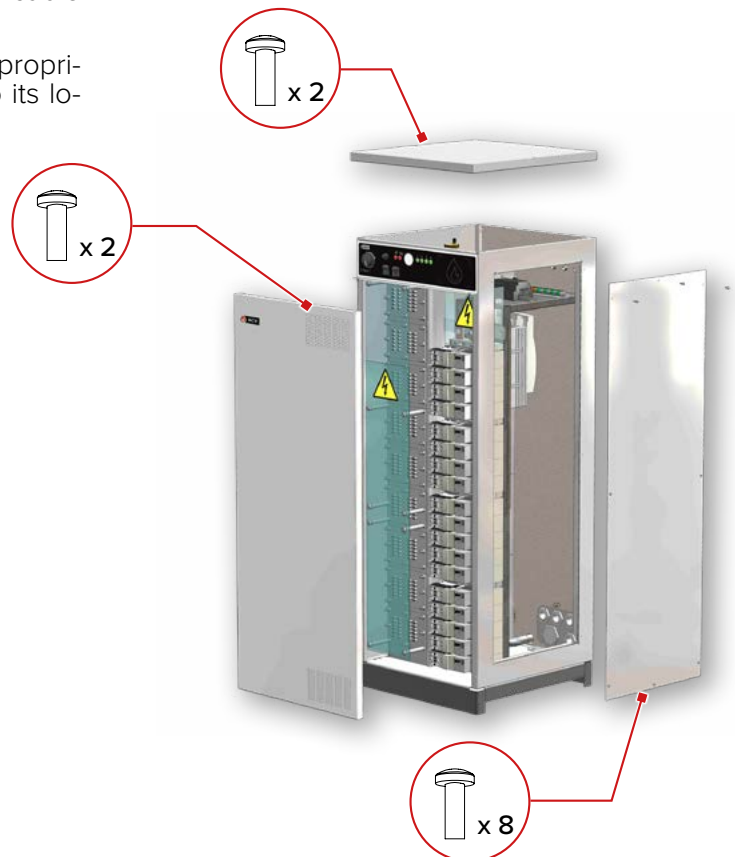

## RECOMMENDATIONS FOR THE HYDRAULIC INSTALLATION

- ☞ Thoroughly rinse the system before connecting the boiler
- Water treatment is recommended to prevent corrosion and the formation of scale in the boiler and piping.
- If the boiler is to be installed in an existing system, ACV recommends using a cleaning agent in the systems.
- After connecting the hydraulic circuit, check the absence of leaks.
- The boiler is designed to operate on a sealed system (ie. no open vent or feed and expansion tank).
- An adequate expansion vessel, sized accordingly must be installed in the system

## HEATING CONNECTION



Make sure to install isolating valves on the system heating circuit, so as to be able to drain the boiler, without draining the whole system.

### Typical system - high temperature

1. Isolation valve
2. Circulating pump
3. Filling valve
4. Check valve
5. Expansion vessel
6. Safety valve (built-in - 4 bar)
7. Draining valve
8. Automatic air vent (built-in)

— Cold water  
— Hot water

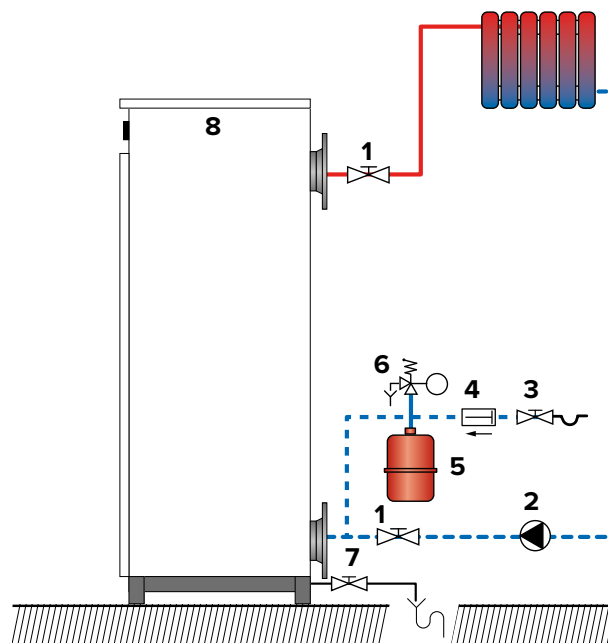

### Essential recommendation for the correct operation of the system

- The drain valve (7) and safety valve (5) must be connected to the sewage system.
- The boiler is equipped with a safety valve set at 4 bar.

## HEATING CIRCUIT + DHW (2 CIRCULATING PUMPS)

Essential recommendation for the correct operation of the system.

- The controller is factory programmed with DHW priority. To cancel the DHW priority, remove the black wire from I7 and connect to I8 in the electronic controller.
- Size the flow rate in hydraulic circuit to ensure a max. 10°C ΔT.

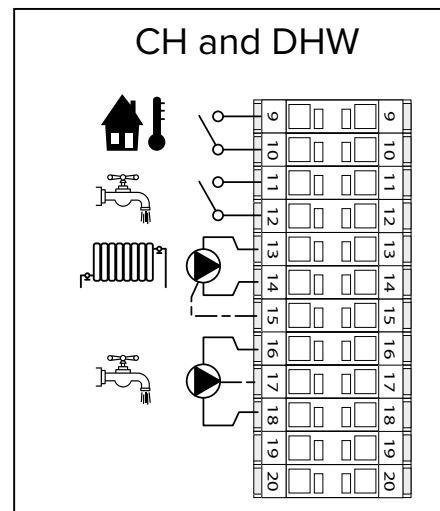
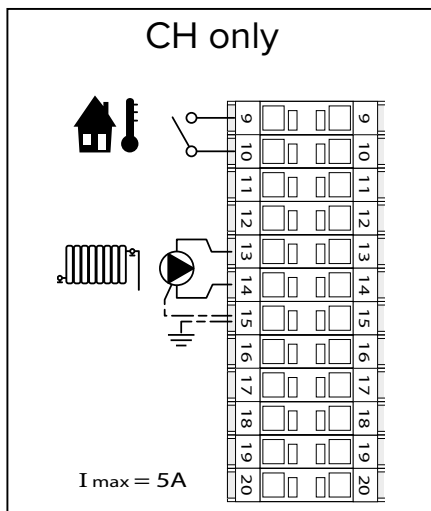
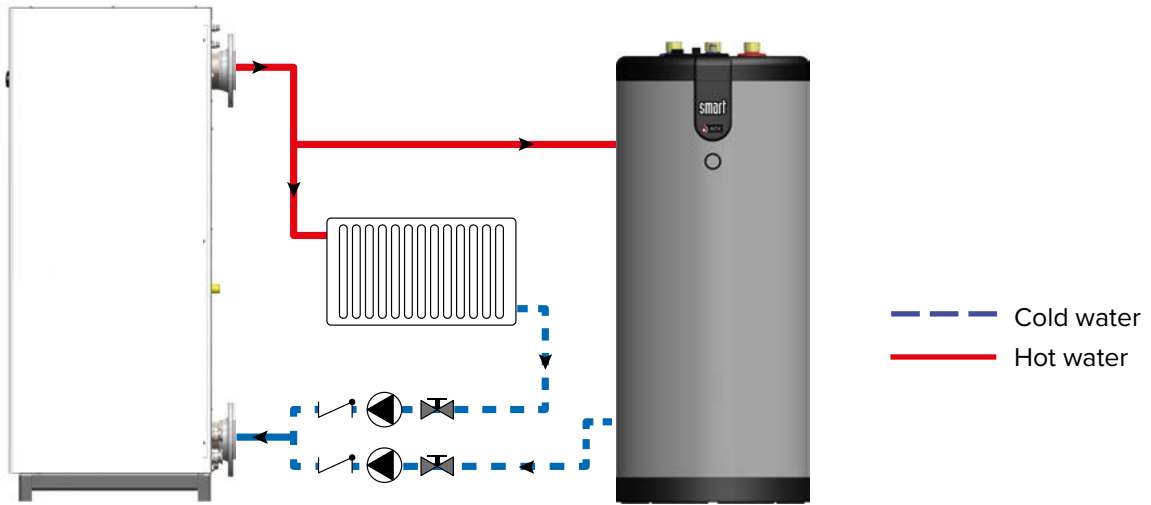
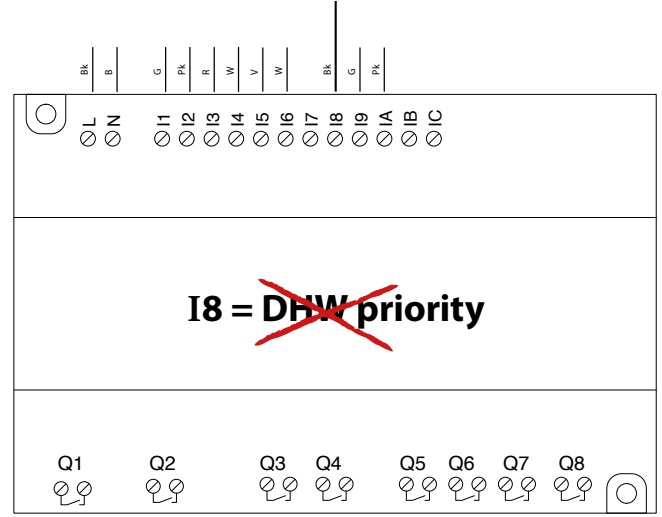
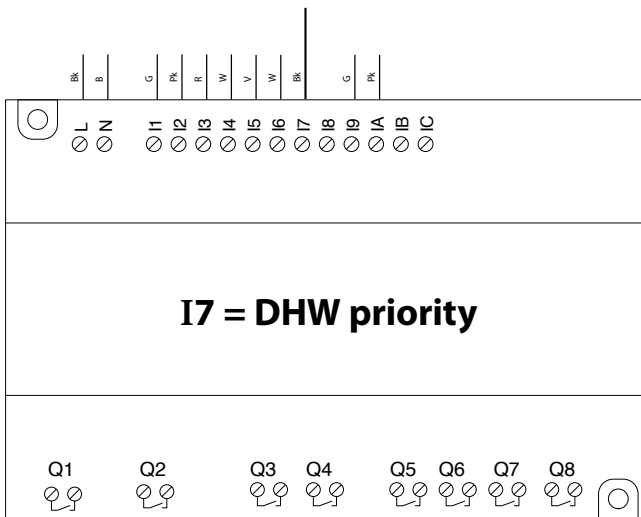

## SAFETY INSTRUCTIONS FOR THE ELECTRICAL INSTALLATION



- Electrical connections must be carried out by a qualified technician, in accordance with regulations applicable to electrical systems.
- Make sure that the boiler is connected to the earth.
- As far as the power input to the boiler is concerned, the installation must comply with standard EN 60364-1 that define the applicable levels of insulation, and with all provisions applicable to installation conditions.
- For protection against electrical hazard, it is always recommended to install a differential cut-out device (Ground Fault Isolator) on the power supply circuit, upstream of the boiler.
- The control circuit is protected by a 3A magnetic circuit breaker.
- The default electrical safeties integrated in the boiler protect the internal parts of the boiler.
- Any additional electrical safety device must be installed outside the boiler.
- It is imperative to install a general contactor upstream to electrically disconnect the appliance in case of overheating. The contactor coil will be connected to terminals 7 and 8 of the general terminal block (see next page).

## ELECTRICAL CONNECTIONS

1. Remove the right and top panel of the boiler, see *"Removal and Installation of the Access Panels"* on page 10.
2. Connect the single phase 230 V power supply on the control circuit connector, as well as all the accessories (room thermostat, etc...)
3. Pass the power cables through the glands located at the bottom of the rear panel.

Models	Std glands	optional glands (*)
E-Tech P 57	1 x PG 36	4 x PG 21
E-Tech P 115	1 x PG 48	4 x PG 21
E-Tech P 144	1 x PG 48	4 x PG 21
E-Tech P 201	4 x PG 29	1 x PG 48
E-Tech P 259	4 x PG 29	1 x PG 48

4. Connect the boiler to the earth using a ring terminal.
5. Open the power connection box.
6. Remove the bottom protection.
7. Connect the power wires to the mains using ring terminals.

\* Optionally, the installer has the possibility to remove the standard cable glands and install the optional cable glands (not supplied) on site.

\*\* A transformation kit is supplied with the boiler in order to connect the power wires using compression terminals (see detailed instructions sheet in the kit).

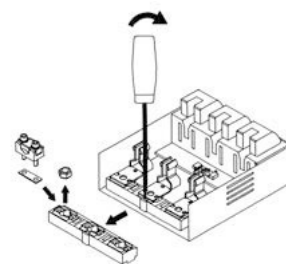

Optional connection\*\*

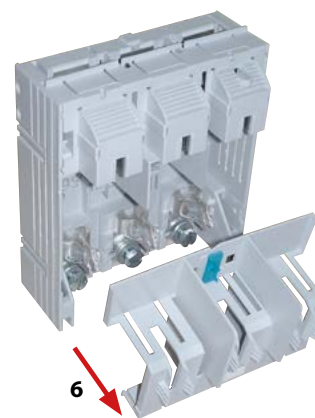
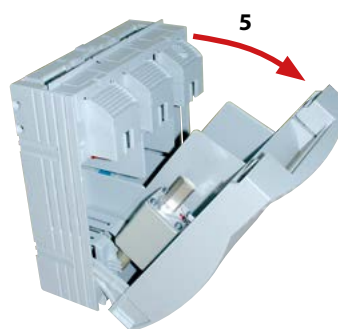

## POWER LIMITATION

The maximum power of the boiler can be limited from 25 to 100% by acting on the SW1, SW2 electrical bridges as mentioned in the table below:

SW1	SW2	E-Tech P				Stage
		57 & 115	144	201	259	
0	0	25%	30%	29%	22%	1
0	1	50%	60%	57%	50%	2
1	0	75%	80%	79%	72%	3
1	1	100%	100%	100%	100%	4



**Essential recommendation for the correct operation of the system.**

- Any change to the power limitation will alter the current once the boiler has switched to stand-by (busy signal is OFF). The external management system can then open the ON/OFF link.

## SIZING OF SUPPLY WIRES

The supply wires are sized depending of the type and current of the MCB. The MCB last is sized depending of the nominal current of the boiler. The admissible current of the supply wires depends of the ambient temperature, the section, the length and the insulation of the wires, the wires ducts, the mounting and the environment.

The following values are given for information for an ambient temperature of 25°C and a maximum length of 5 meters. In all the circumstances, the installation must be in accordance with the current wiring regulations.

Diameter (mm <sup>2</sup> )	Current (Amp)
1,5	16
2,5	25
4,6	36
10	47
16	65
25	87
35	115
50	143
70	178
95	220
120	265
150	310
185	355
240	480

## CONTROL CIRCUIT TERMINAL

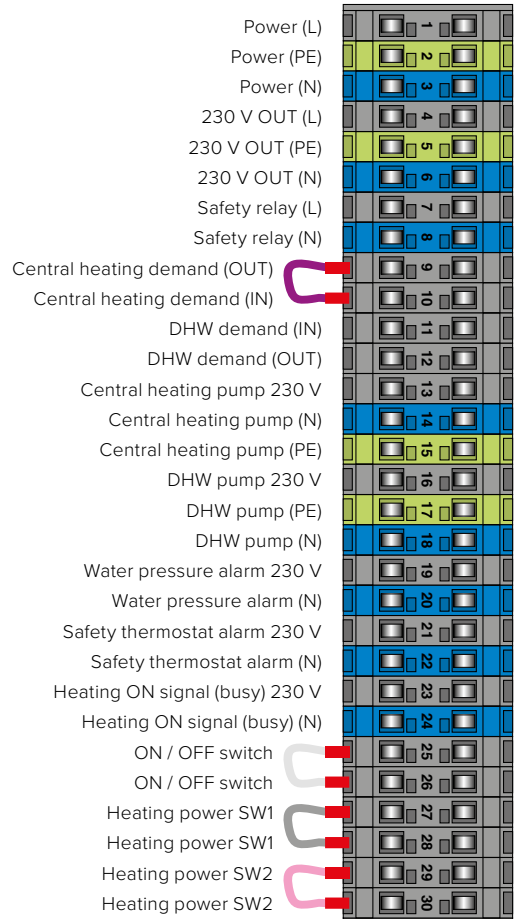

For higher temperatures, the supply wire diameter should be adapted according the derating factor.

Ambient T° (°C)	Current derating (%)
25	100
30	92
35	85
40	75
45	65
50	53
55	38

## SAFETY INSTRUCTIONS FOR STARTING UP



### Essential recommendations for safety

- The components inside the boiler may only be accessed by an approved installer.
- Set the water temperature in accordance with usage and local plumbing codes.
- Make sure that the heating circuit filling valve is closed once the starting up process is complete.
- Make sure that all connections are made and tight.

## CHECKS AND SETUP BEFORE START UP

### Set-up conditions

- Boiler shut down using the ON/OFF switch
- External power supply isolated (through the external electrical box).

### Procedure

1. Remove the top, front and right side panels. See "*Removal and Installation of the Access Panels*" on page 10.
2. Place the internal circuit breaker to OFF (See "*12. Circuit breaker 3A 400 V*" on page 17, ML section).
3. Check that all electrical connections are tight, and more particularly the attachment nuts of the heating elements (nominal torque: 10 Nm).
4. Check that all internal relays and contactors are secure on the DIN rails.
5. Place control thermostat on the required temperature.

## FILLING THE SYSTEM



If the system is fitted with an external hot water tank, first put the DHW circuit under pressure before pressurizing the heating (primary) circuit. Refer to the hot water preparation tank manual for more information.

### Set-up conditions

- External power supply isolated
- DHW circuit (if any) under pressure

### Filling procedure

1. Open the isolating valves (1).
2. Make sure that the drain valve (3) is tightly closed.
3. Open the filling valve (2).
4. Make sure the air vent is open, as required.
5. Once the system is bled from air, bring the pressure to the static pressure at 1.5 bar
6. Close the filling valve (2)

### Follow-on tasks

- Check there is no leak.

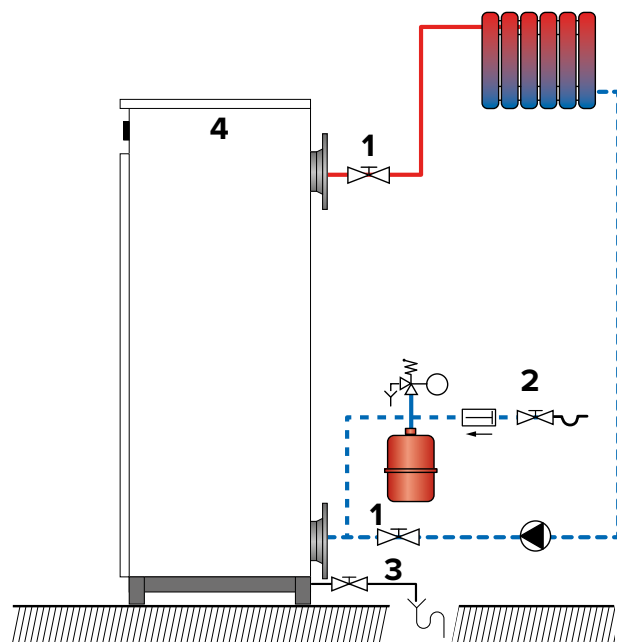

— — Cold water  
 — — Hot water

## STARTING THE BOILER

### Set-up conditions

- Hydraulic and electric connections made
- External power supply isolated
- Boiler on/off switch to “Off”
- Hydraulic circuit filled and under pressure

### Procedure



**Before starting the boiler, make sure that the air is bled from the heating circuit using the automatic air vent located at the top of the boiler. Note that the black dust cap on the air vent should be left loose to allow the auto vent to function.**

1. Set the internal MCB to ON (See "12. Circuit breaker 3A 400 V" on page 17, ML Section).
2. Reinstall the removed access panels, refer to "Removal and Installation of the Access Panels" on page 10.
3. Provide power supply to boiler through the external electrical box.
4. Place boiler On/Off switch to “On”.
5. Check that the following sequence takes place :
  - The indicator shows that the first stage is activated.
  - The combined thermometer and pressure gauge indicates the rise in temperature.
  - As long as the preset temperature is not reached, one additional stage is activated every 2 minutes, until all stages are activated.
  - Once the temperature set on the control thermostat is reached, one stage is deactivated at a time every 30 seconds, until all stages are deactivated.
6. After a few minutes of operation of the circulating pump in the system, place the On/Off switch of the boiler (1) to Off.
7. Bleed the air from the system and adjust the pressure to the static pressure (height: 1 bar = 10 m - 1,5 bar = 15 m) + 0,5 bar. (min. pressure: 0,8 bar). Check the pressure on the combined thermometer and pressure gauge.
8. The boiler is now ready to operate.
9. Place the boiler On/Off switch (1) to “On”.

### Follow-on Task(s)



**After several days of operation, re-check all electrical and hydraulic connections for tightness, as well as the system operating pressure. Correct and adjust as necessary.**

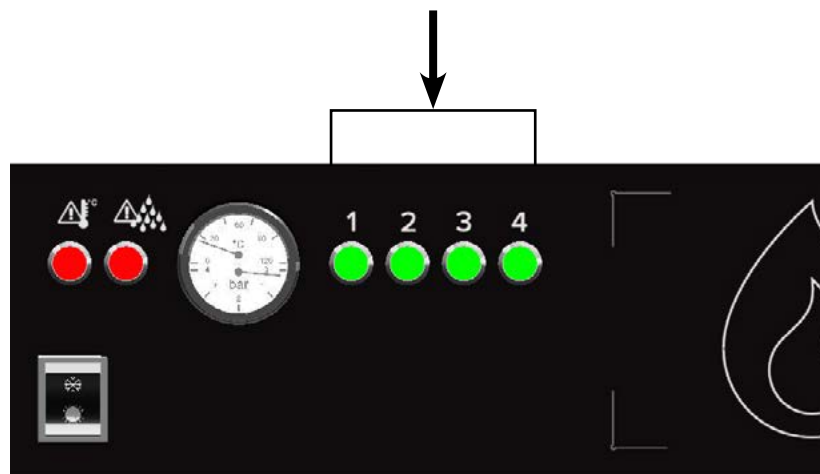



## RECOMMENDATIONS FOR THE BOILER MAINTENANCE



### Essential recommendations for the electrical safety

- Before opening the boiler for maintenance, turn off the boiler by pushing on the ON/OFF master switch.
- Isolate the external power supply of the appliance before performing any operation, unless it is required to take measurements or perform system setup.



### Essential recommendations for safety

- Water flowing out of the drain valve may be extremely hot and could cause severe scalding.
- Do not use solvents to clean any of the components. The components could be damaged, resulting in unreliable or unsafe operation.



### Essential recommendations for the correct operation of the appliance

- It is recommended to have the boiler serviced at least once a year or every 1,500 hours by a qualified technician, preferably at the start of the heating season. More frequent servicing may be required depending on boiler use. Please consult your installer for advice.
- The boiler maintenance will be carried out by a qualified engineer, and the defective parts may only be replaced by genuine factory parts.
- Make sure to replace any gaskets or seals on the removed components before reinstalling them.
- Control the tightness of the hydraulic circuit connections.

## BOILER SHUT-DOWN FOR MAINTENANCE

1. Switch the boiler off using the ON/OFF master switch
2. Isolate the external power supply.

## DRAINING THE BOILER

### Set-up conditions

- Boiler shut down through the ON/OFF switch
- External power supply isolated (through the external electrical box)
- Boiler cooled down (if it was in operation)
- Top cover removed to access the air vent. Refer to *"Removal and Installation of the Access Panels"* on page 10.

### Procedure

1. Close the heating circuit isolating valves (1)
2. Open the draining valve (2) and allow the water to flow to the drain
3. Actuate the automatic air vent (3).

### Follow-on Task(s)

Reinstall the access panels, refer to *"Removal and Installation of the Access Panels"* on page 10.

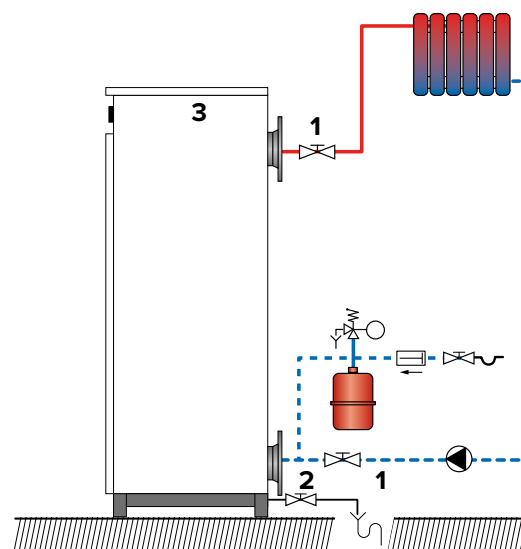

--- Cold water  
 — Hot water



Before carrying out any work on the system ensure that the boiler is cool and all electrical supplies are isolated.

## BOILER MAINTENANCE

### Set-up conditions

- Boiler shut down using the ON/OFF switch
- External power supply isolated (through the external electrical box)
- Boiler cooled down (if it was in operation)

### Procedure

1. Remove access panels. Refer to *"Removal and Installation of the Access Panels"* on page 10.
2. Perform a visual inspection of the boiler looking out for signs of water leakage from joints, expansion vessel, and the area around the elements on top of the boiler.
3. Perform a visual inspection of all wiring and cables in the boiler casing, checking for signs of overheating or burning.
4. Check all push-on electrical connectors for tightness and good connection to the relative components.
5. Using an appropriate screwdriver, check all electrical terminals on DIN rails and on all components for tightness.
6. Check all individual circuit breakers are in the normal position. If some fuses have tripped, check the wiring and the resistance before re-activating them.
7. Check the condition of the heating elements.

### Follow-on task(s)

1. Replace the heating elements if necessary. See *"Replacing the Heating Elements"* on page 19
2. Restart the boiler, refer to *"Starting the boiler"* on page 16.

## CHECKING THE SAFETY DEVICES

1. Check the correct operation of the thermostats and safety devices.
2. Check the heating circuit safety valves, and those in the DHW circuit, as required.
3. Check the correct operation of the automatic air vent.

## RESETTING THE HIGH LIMIT SAFETY THERMOSTAT

### Set-up conditions

- Boiler shut down through the ON/OFF switch
- External power supply isolated (through the external electrical box)
- Boiler cooled down (if it was in operation) to <math><60^{\circ}\text{C}</math>

### Procedure

1. Unscrew and remove the cover from the safety thermostat.
2. Press the safety thermostat to reset it.
3. Reinstall the cover on the safety thermostat.

### Follow-on task(s)

1. Activate electrical power through the external electrical box
2. Turn the boiler on using the ON/OFF switch.
3. Check that the overheating indicator is turned off.

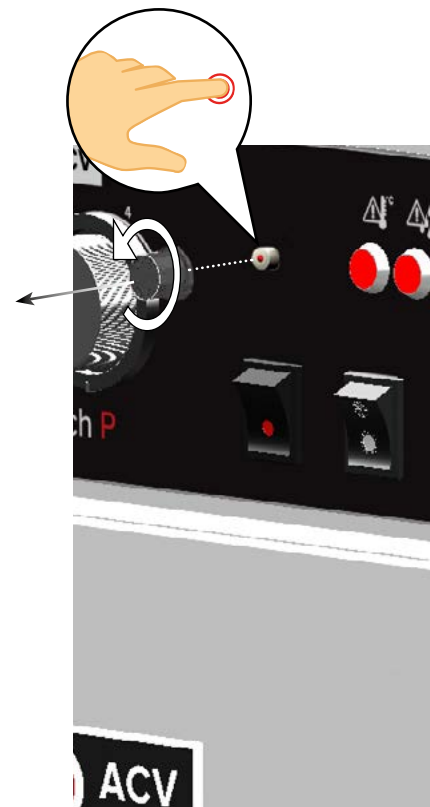

## REPLACING THE HEATING ELEMENTS

### Set-up Conditions

- Boiler shut down using the ON/OFF switch
- External power supply isolated (through the external electrical box)
- Boiler cooled down (if it was in operation)

**Before carrying out any work on the system ensure that the boiler is cool and all electrical supplies are isolated.**

### Procedure

1. Remove the front and side access panels (see *"Removal and Installation of the Access Panels"* on page 10).
2. Release eight nuts from the heating element support plate. Retain for reinstallation.
3. Remove the plate and the heating elements, as well as the seal (2).
4. Replace the heating elements (1).
5. Replace the seal.
6. Reinstall the plate and the heating elements in the boiler, with the seal (2).

7. Tighten the eight screws in the order shown at the bottom of the page.
8. Replace the main fuses (if necessary).

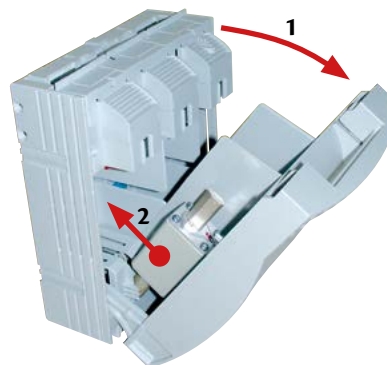

### Follow-on Tasks

1. Check all the electrical connections
2. Close all open access panels. See *"Removal and Installation of the Access Panels"* on page 10.
3. Restart the boiler. See *"Starting the boiler"* on page 16.

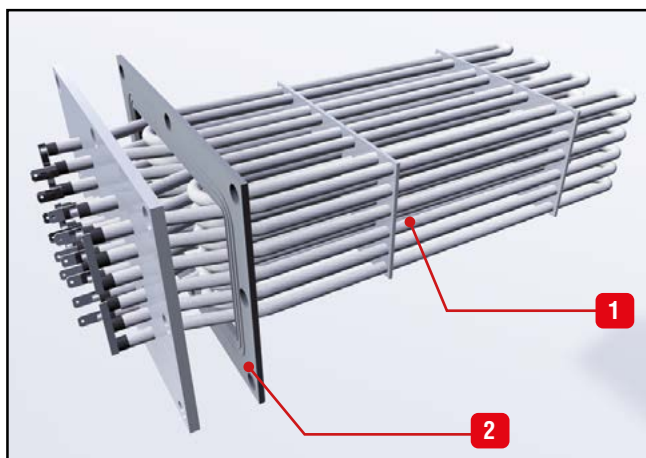

Ohmic value : 22 Ω

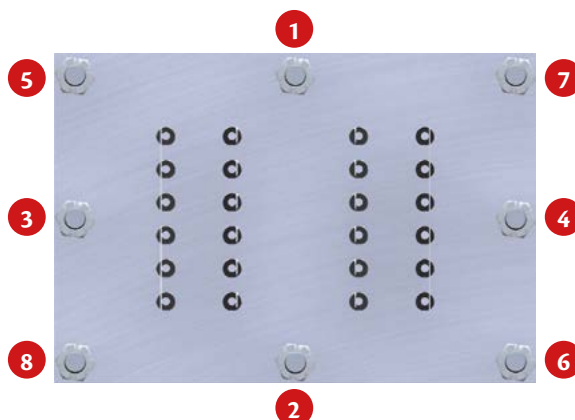

Torque = 10 Nm



**Make sure to tighten the nuts in the sequence shown**

ACV International  
Oude Vijverweg, 6  
B-1653 Dworp  
Belgium  
[belgium.service@acv.com](mailto:belgium.service@acv.com)  
[www.acv.com](http://www.acv.com)